

IN01-A

Time & Attendance and Access Control Terminal



IN01-A is an innovative biometric fingerprint reader for time attendance and access control applications, Built-in 2000 mAh backup battery can eliminate power-failure problems. The IN01-A supports optional GPRS and Wi-Fi and features the fastest commercial-based fingerprint matching algorithm and ZK high-performance, high-image quality optical fingerprint sensor. The 3" TFT can display more information vividly, including fingerprint image quality and verification result etc. TCP/IP communication is standard and makes sure the data transmission terminal and PC can be easily done within several seconds.

Features

- 3" Color TFT screen
- ZK Fingerprint Sensor
- Reads Fingerprint and/or Card
- Multi-language in text and audio
- Built-in Serial and Ethernet ports
- Built-in battery backup provides approx. 4 hours continuous operation
- Optional built-in wireless Wi-Fi or GPRS for wireless communication
- SDK available for OEM customers and software developers

Specifications

Fingerprint Capacity	3.000
Record Capacity	100.000
Display	3-inch Screen
Communication	TCP/IP, RS232-485, USB-host/client
Standard Functions	Work code, SMS, DST, Built-in Battery, Multiple Verify Mode, Self-Service Query, Automatic Status Switch
Optional Functions	ID/Mifare/HID, External Printer and Bell
Software	ZKTime. Net 3.0, ZKTime Enterprise/Lite
Power Supply	DC 12V 3A
Verification Speed	≤0.5 Sec.
Operating Temp.	0 °C- 45 °C
Operating Humidity	20%-80%
Dimension	211,5 × 159,4 × 47,8 mm (Length × Width × Thickness)
Net Weight	1.40 kg

Configuration

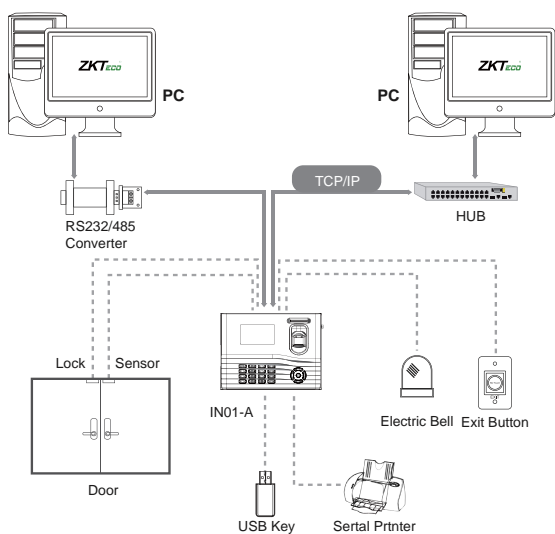

Dimensions

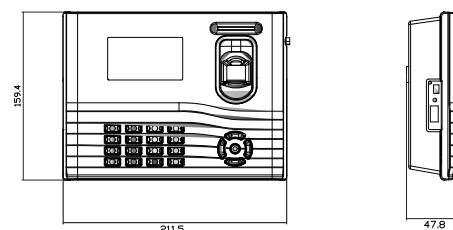

Interface

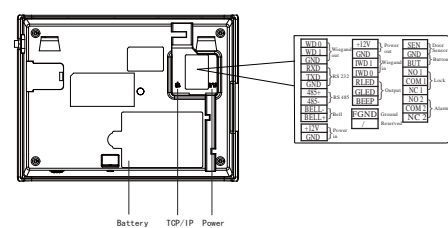

What's in the Box

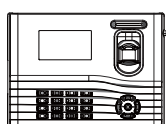

IN01-A

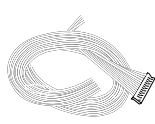

Lines for Access Control Interface



Software CD (ZKTime Net)

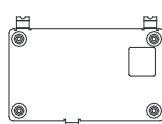

Back Plate



Screws and Holders

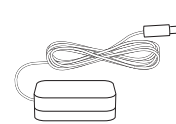

Power Adapter

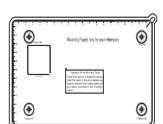

Mounting Paper

ZKTeco Europe.

Av. Camino de lo Cortao, 10. Nave 1.
28703 San Sebastián de los Reyes. Madrid. SPAIN
Tel: +34 916 532 891 E-mail: sales@zktechnology.eu
www.zkteco.eu

© Copyright 2015. ZKTeco Inc. ZKTeco Logo is a registered trademark of ZKTeco or a related company. All other product and company names mentioned are used for identification purposes only and may be the trademarks of their respective owners. All specifications are subject to change without notice. All rights reserved.

